

# P-0009 / P-0018

Postes para barandillas con tuerca remachable / Post with Rivet Nuts / Poteau avec écrou à rivet

|          |                          |          |  |
|----------|--------------------------|----------|--|
| <b>1</b> | <b>Calidad y acabado</b> | AISI 316 | Acabado<br><input type="checkbox"/> Espejo <input type="checkbox"/> Satinado |
|----------|--------------------------|----------|--|

|  |   |  |
|--|---|--|
| <b>2</b>   | <b>Tipo de Poste y medida del tubo</b>    |  |
| <input type="checkbox"/> P-0009  | <input type="checkbox"/> P-0018           |  |
| <input type="checkbox"/> D= Ø 43mm<br><input type="checkbox"/> D= Ø 50,8mm | <input type="checkbox"/> LxL' = □ 40x40mm |  |

|   |                                       |  |
|---|---------------------------------------|--|
| <b>3</b>  | <b>Tipo de Transversal y cantidad</b> |  |
| Métrica tuercas remachables <input type="checkbox"/> M6 <input type="checkbox"/> M8 |                                       |  |
| T= <input type="text"/> Número tuercas remachables por poste                        |                                       |  |

**3.1 Tramos horizontales / Horizontal section / Parties horizontales**

|                                    |                                |                            |
|------------------------------------|--------------------------------|----------------------------|
| <input type="checkbox"/> H= 910mm  | <input type="checkbox"/> Otras | H= <input type="text"/> mm |
| <input type="checkbox"/> H= 1010mm |                                |                            |

|   |   |  |
|---|---|--|
| <b>Mod. 01</b>  | Poste final derecha con tuerca remachable |  |
|  | uds. <input type="text"/>                 | h1= <input type="text"/> mm<br>h2= <input type="text"/> mm |

|   |  |  |
|---|--|--|
| <b>Mod. 02</b>  | Poste intermedio con tuerca remachable |  |
|  | uds. <input type="text"/>              | h1= <input type="text"/> mm<br>h2= <input type="text"/> mm |

|   |  |  |
|---|--|--|
| <b>Mod. 03</b>  | Poste en esquina con tuerca remachable                 |  |
|  | uds. <input type="text"/><br>G= <input type="text"/> ° | h1= <input type="text"/> mm<br>h2= <input type="text"/> mm |

|   |   |  |
|---|---|--|
| <b>Mod. 04</b>  | Poste final izquierda con tuerca remachable |  |
|  | uds. <input type="text"/>                   | h1= <input type="text"/> mm<br>h2= <input type="text"/> mm |

**3.2 Tramos en escalera / Staircase section / Parties en escalier**

|                                    |                                |                            |
|------------------------------------|--------------------------------|----------------------------|
| <input type="checkbox"/> H= 910mm  | <input type="checkbox"/> Otra: | H= <input type="text"/> mm |
| <input type="checkbox"/> H= 1010mm |                                |                            |

|   |  |  |
|---|--|--|
| <b>Mod. 05</b>  | Poste intermedio con tuerca remachable |  |
|  | uds. <input type="text"/>              | h1= <input type="text"/> mm<br>h2= <input type="text"/> mm<br>h3= <input type="text"/> mm<br>h4= <input type="text"/> mm |

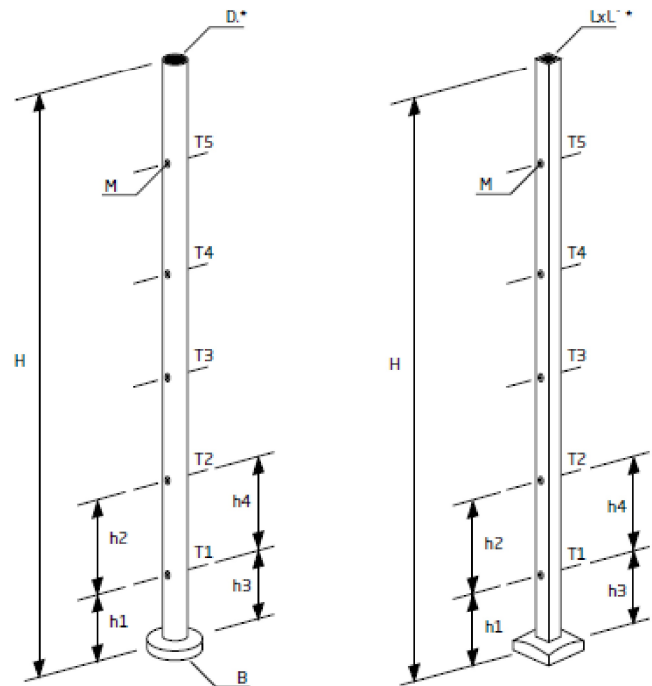











**P-0009**

**P-0018**

\*Tubo de espesor 1,5 mm.

Se toma como vista de referencia la cara externa de la barandilla.

|          |   |   |
|----------|---|---|
| <b>4</b> | <b>Elegir base</b>  |   |
|          | <b>P-0009</b>   | <b>P-0018</b>   |
|          | <input type="checkbox"/> BS-00             | <input type="checkbox"/> BS-10             |
|          | <input type="checkbox"/> con embellecedor  | <input type="checkbox"/> con embellecedor  |
|          | <input type="checkbox"/> SL-1100           | <input type="checkbox"/> SL-1110           |
|          | <input type="checkbox"/> SL-1101           | <input type="checkbox"/> SL-1111           |
|          | <input type="checkbox"/> SL-1120           | <input type="checkbox"/> SL-1130           |
|          | <input type="checkbox"/> Sin Base   |   |